

-
-
-
-
-
-
-
-
-
-
-

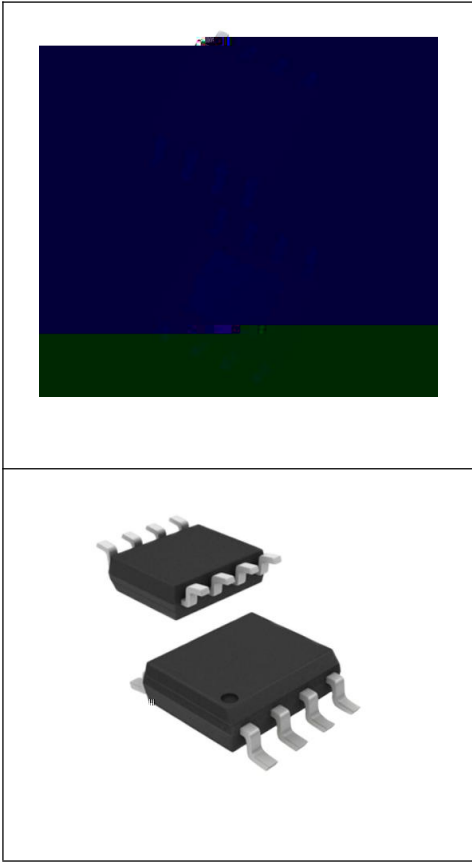

-
-
-
-

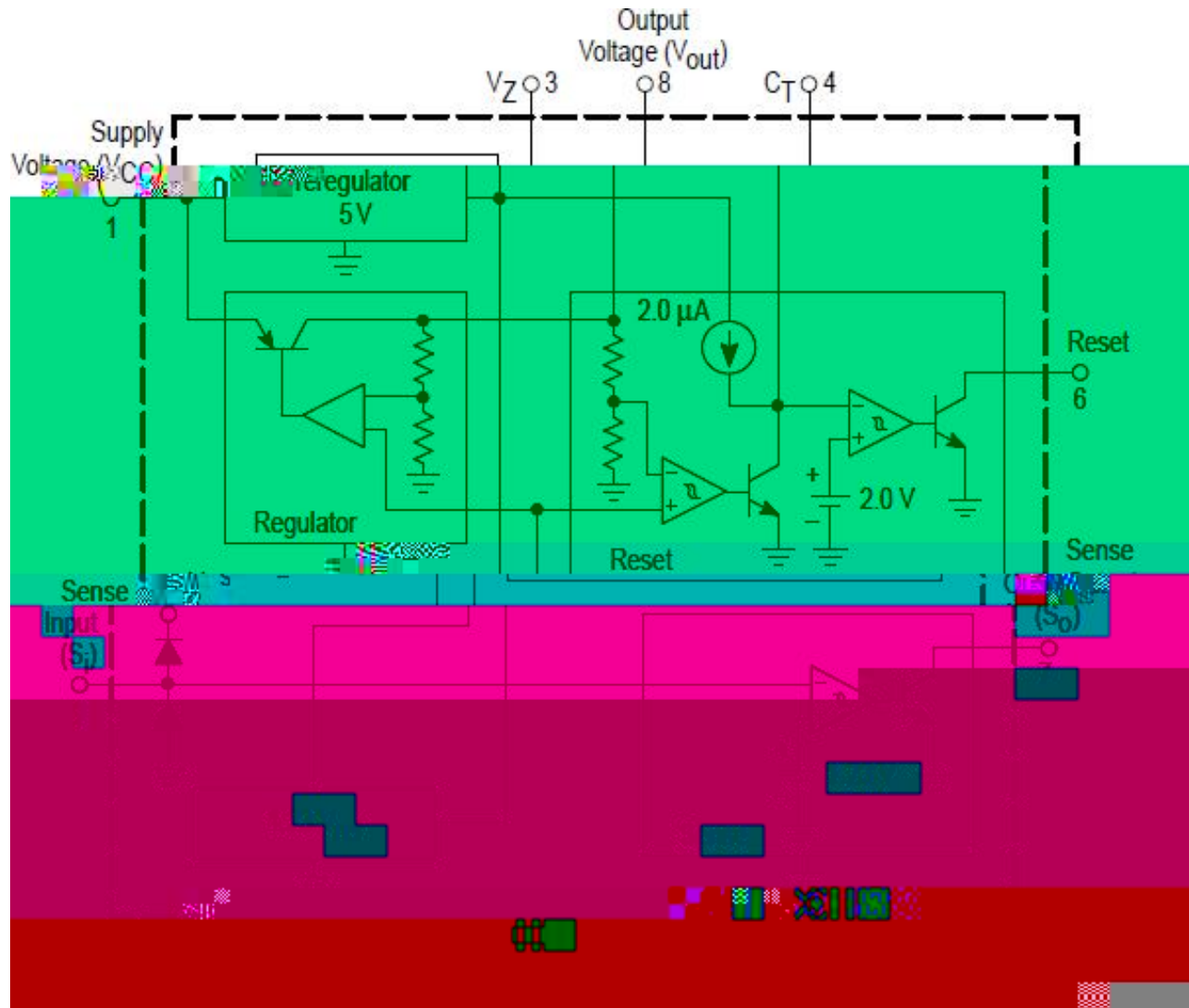

MICHIP

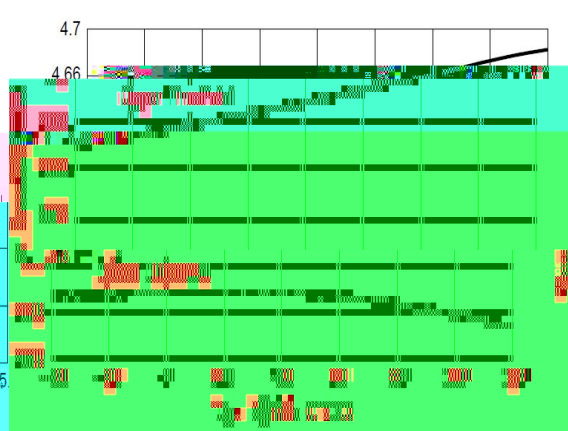
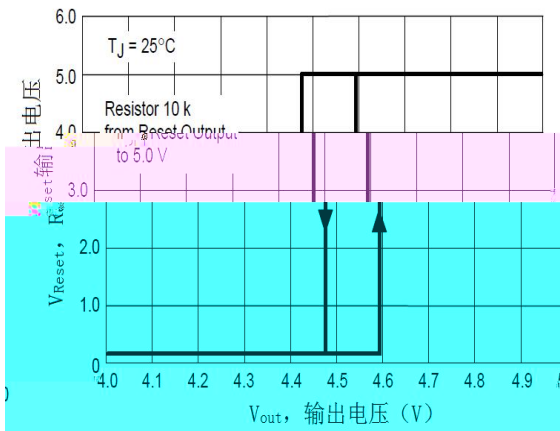
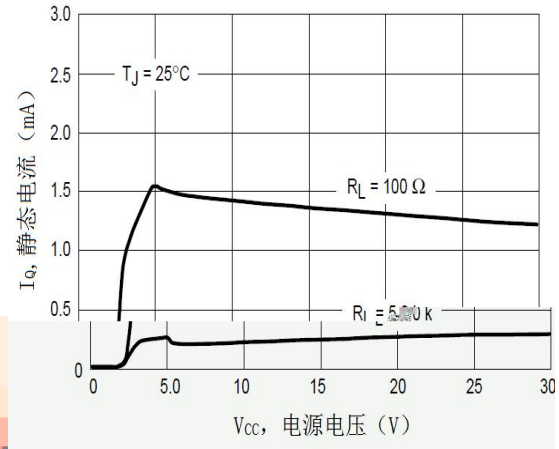
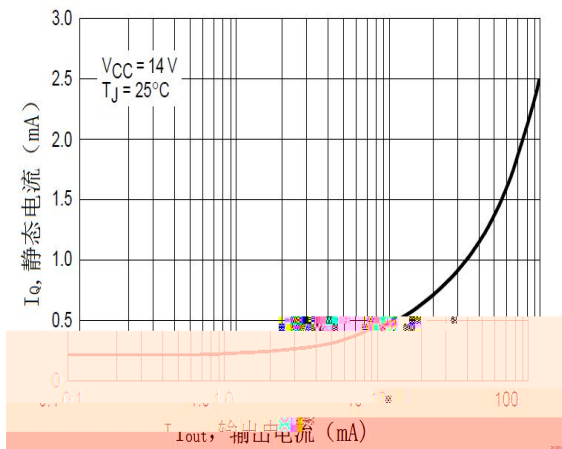
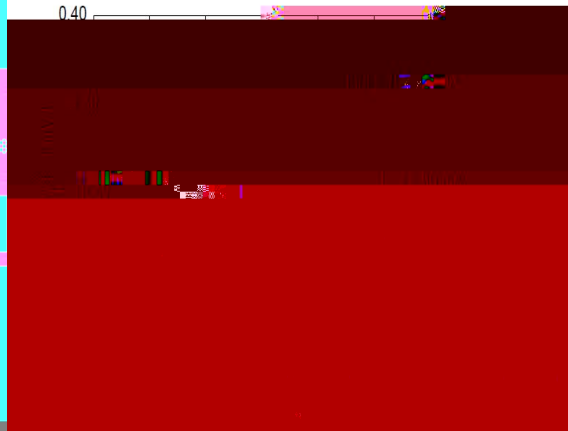
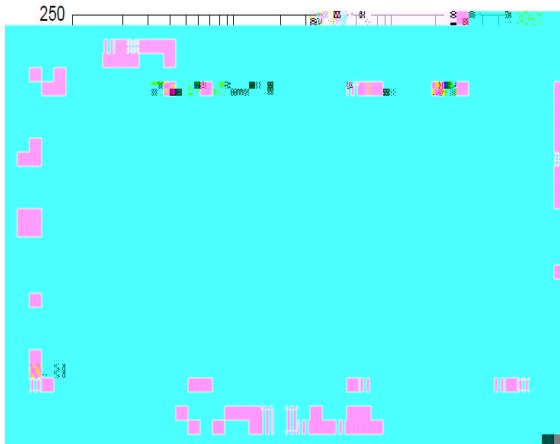

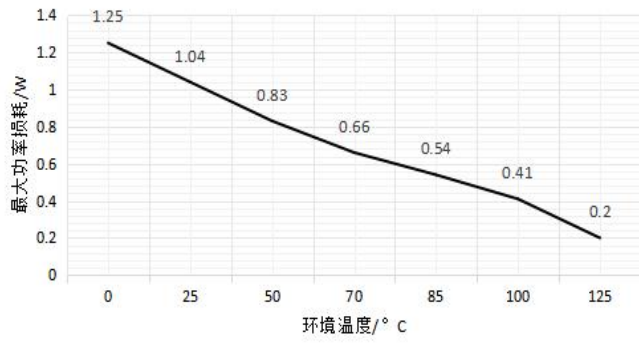
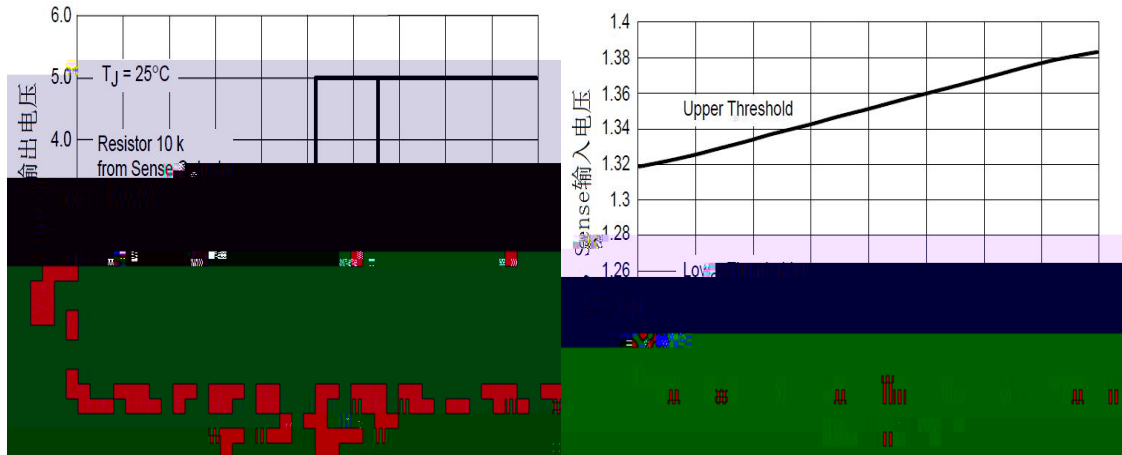

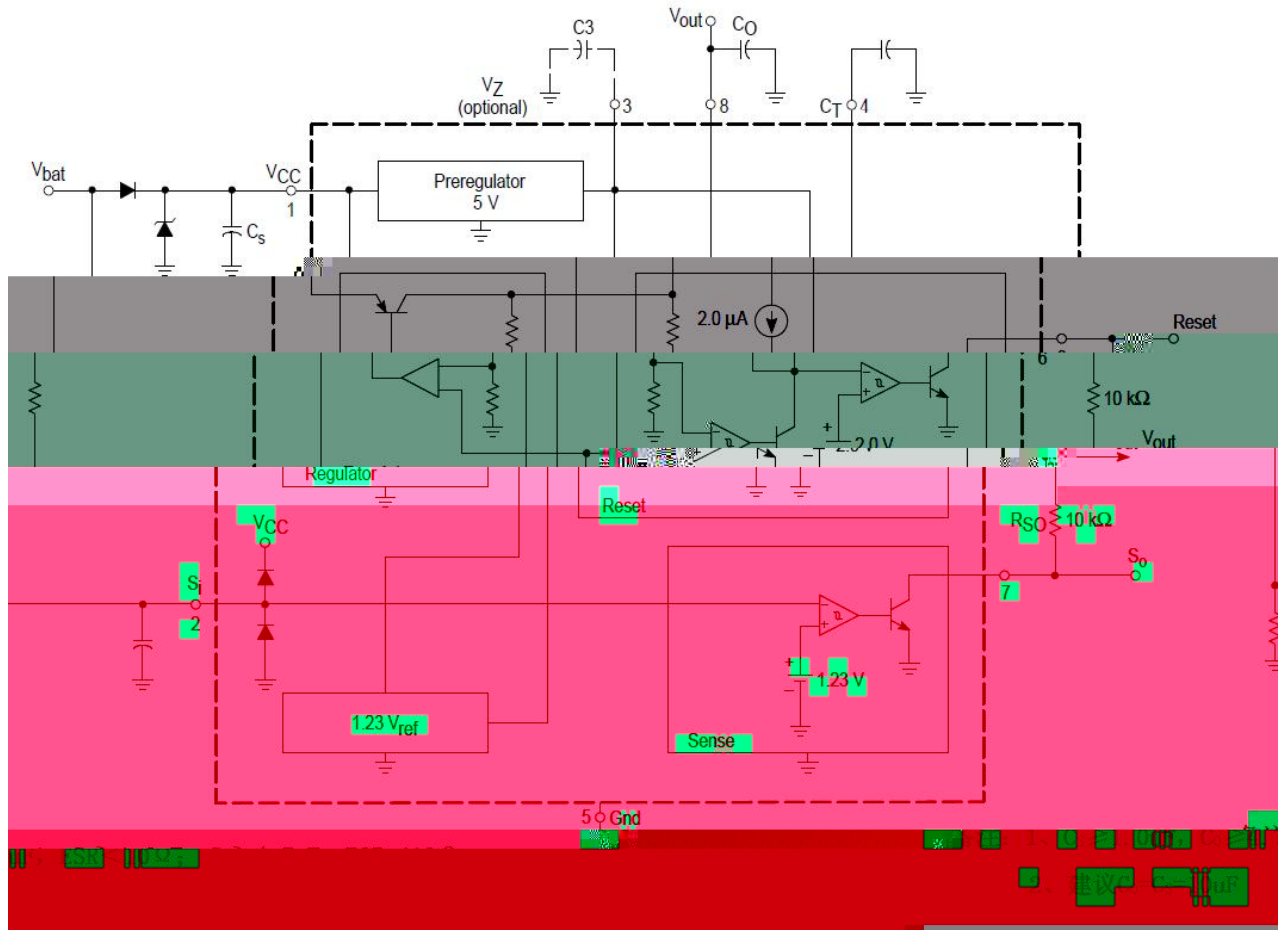

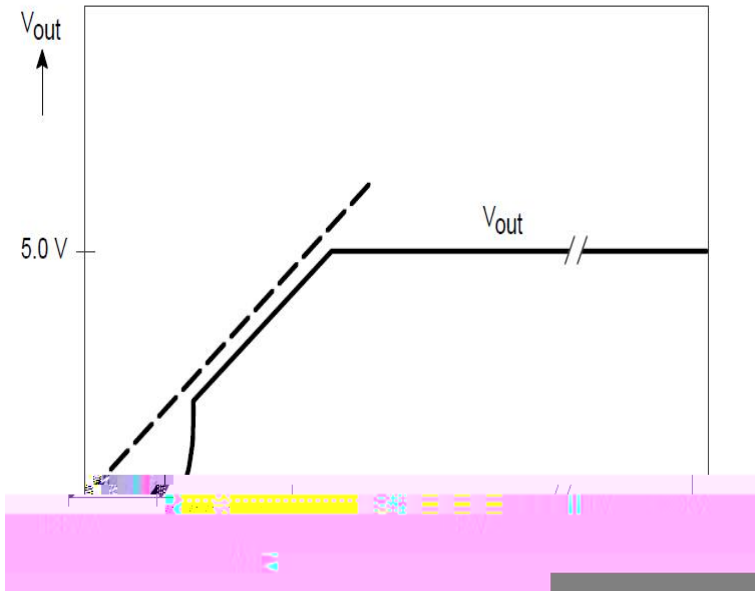

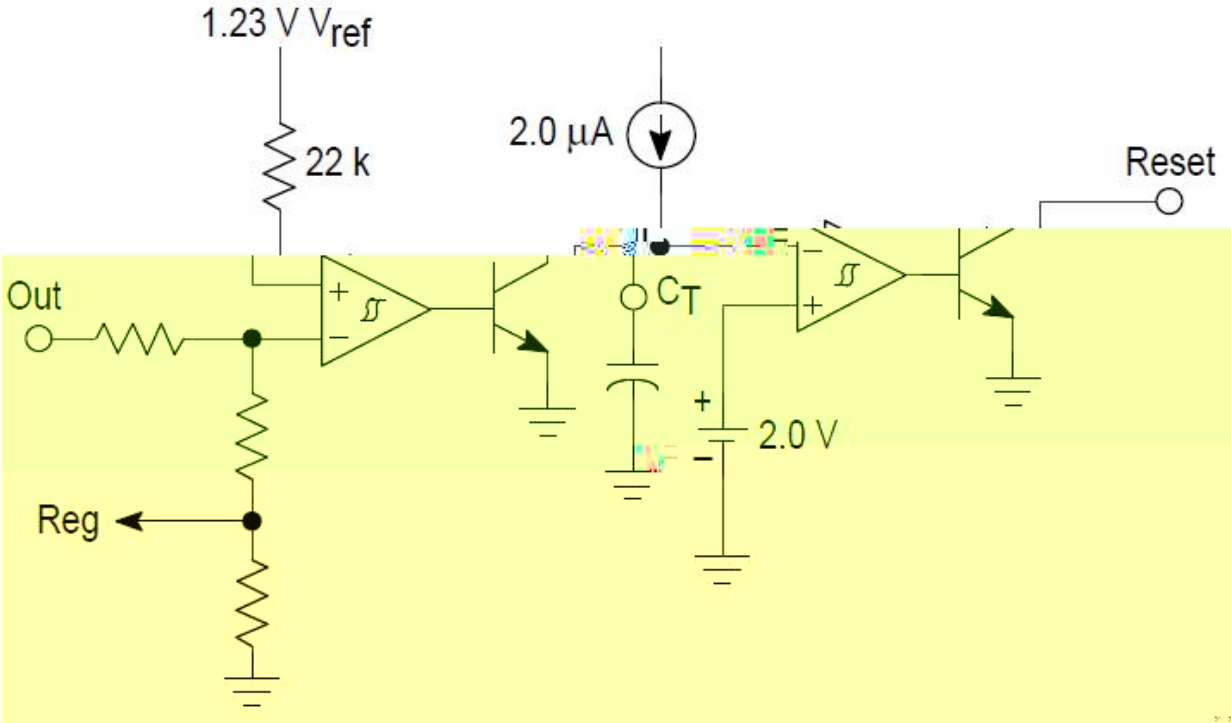

$$R_D = \frac{C \times}{A}$$

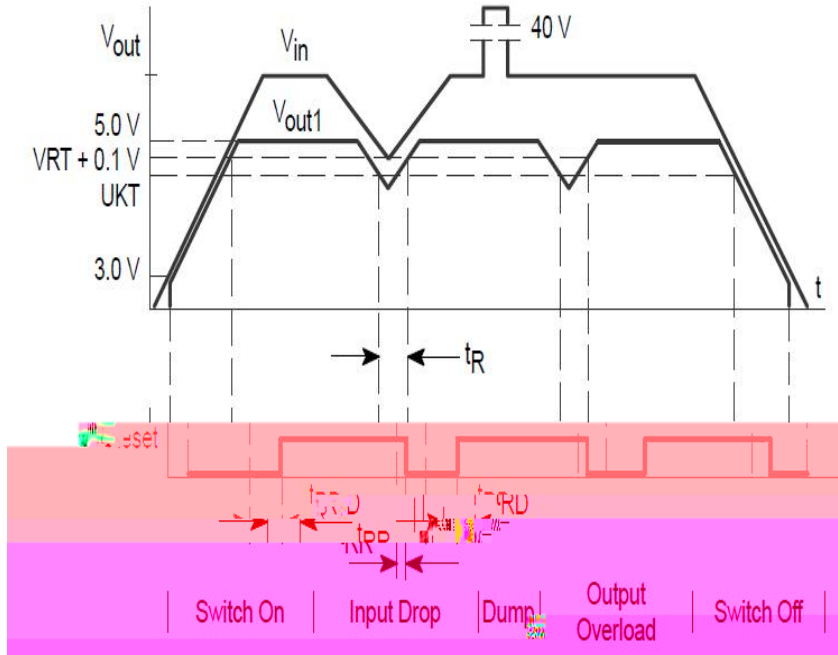

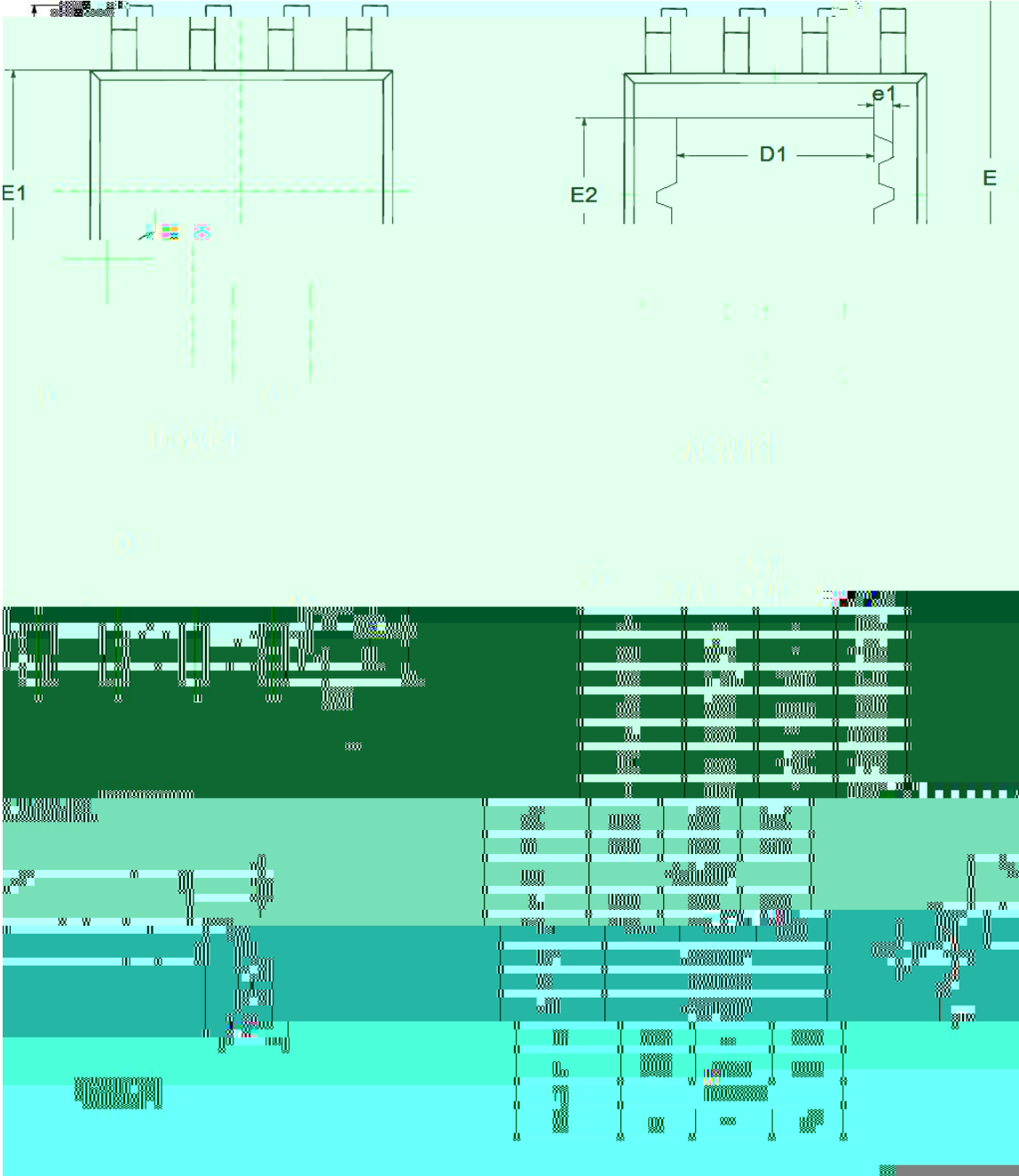

MICHIP
