







**MICHIP**

---



# MICHIP

---

	Δ					
--	---	--	--	--	--	--

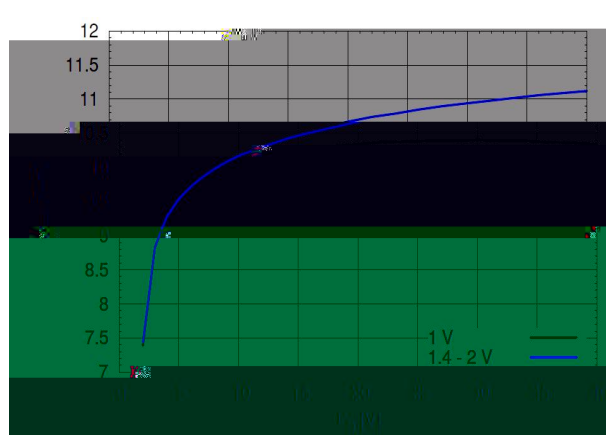
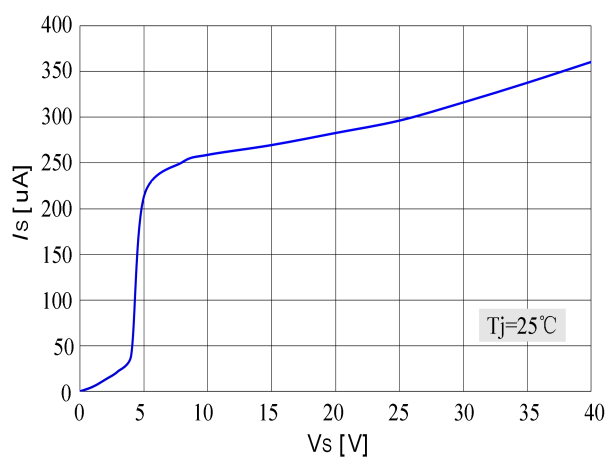
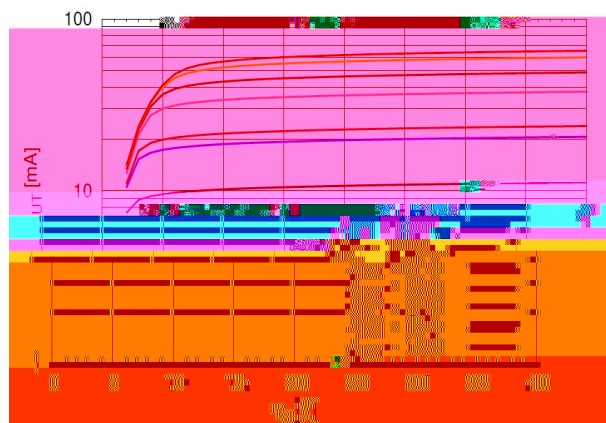
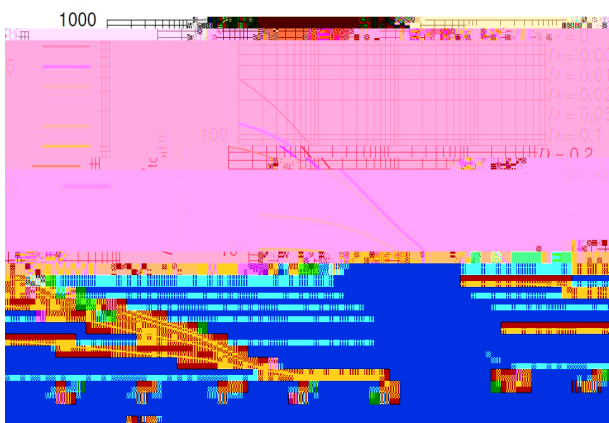
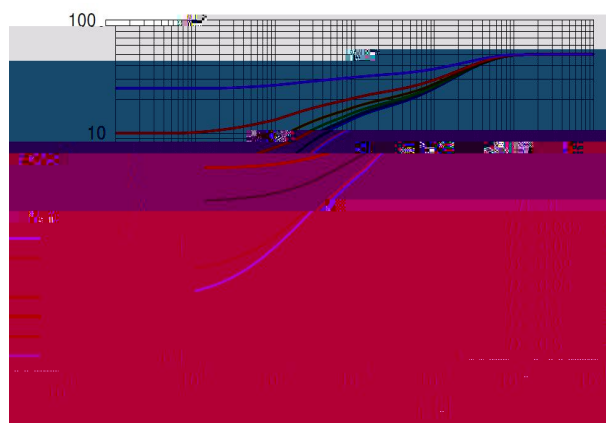
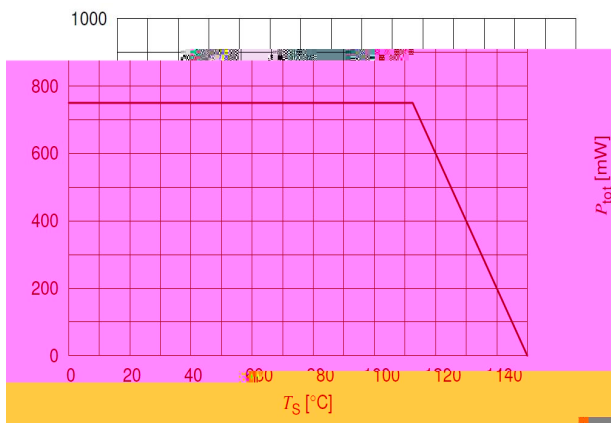

**MICHIP**

---

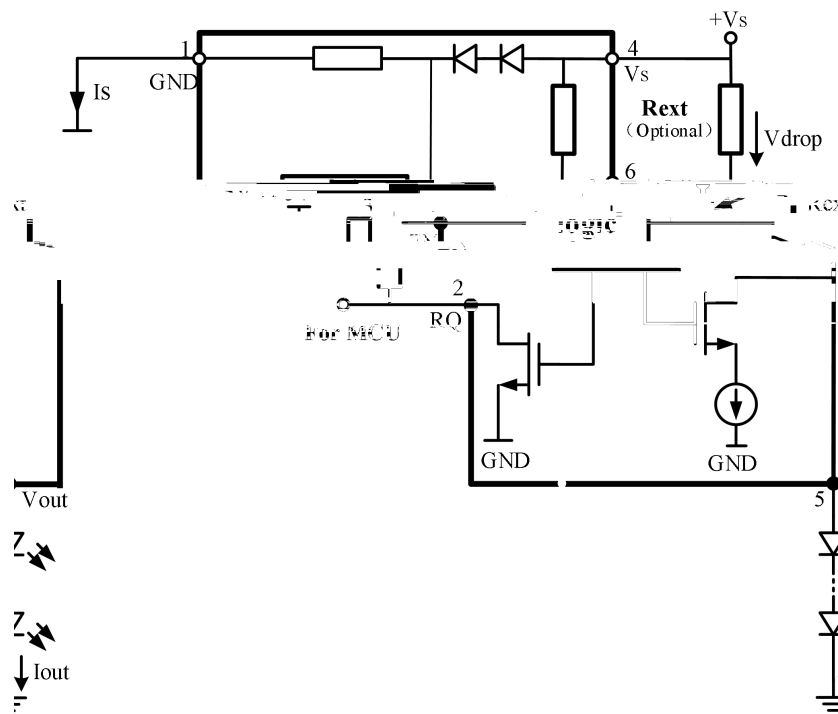

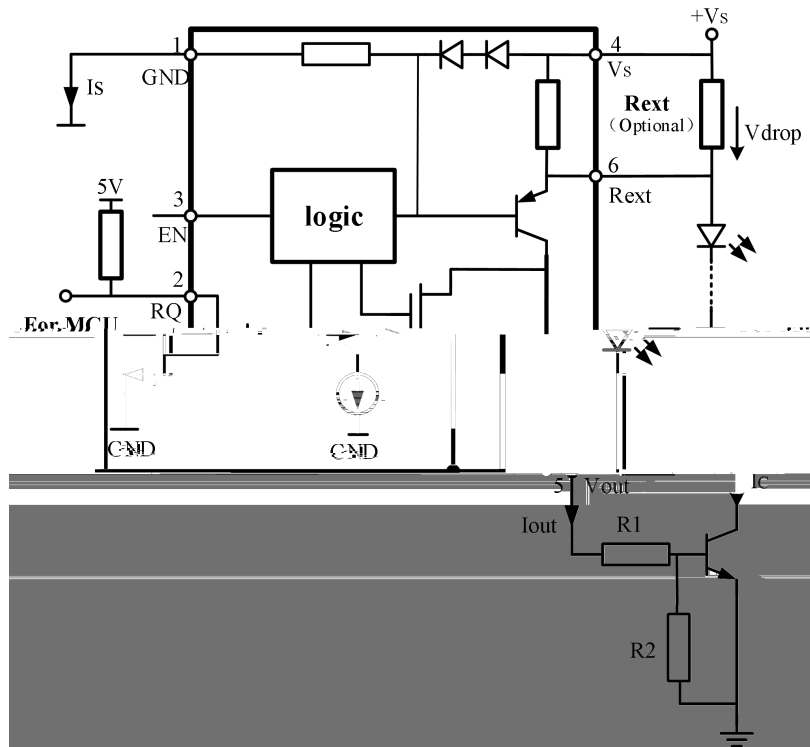

$$I_{out} = \frac{drop}{R_1} + I_{out} -$$

$$V_{R1} = (V_S - 0.7V) \frac{R_1}{R_1 + R_{int}}$$

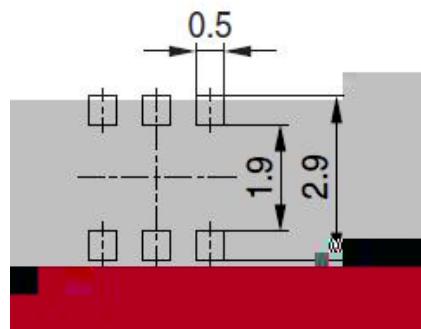
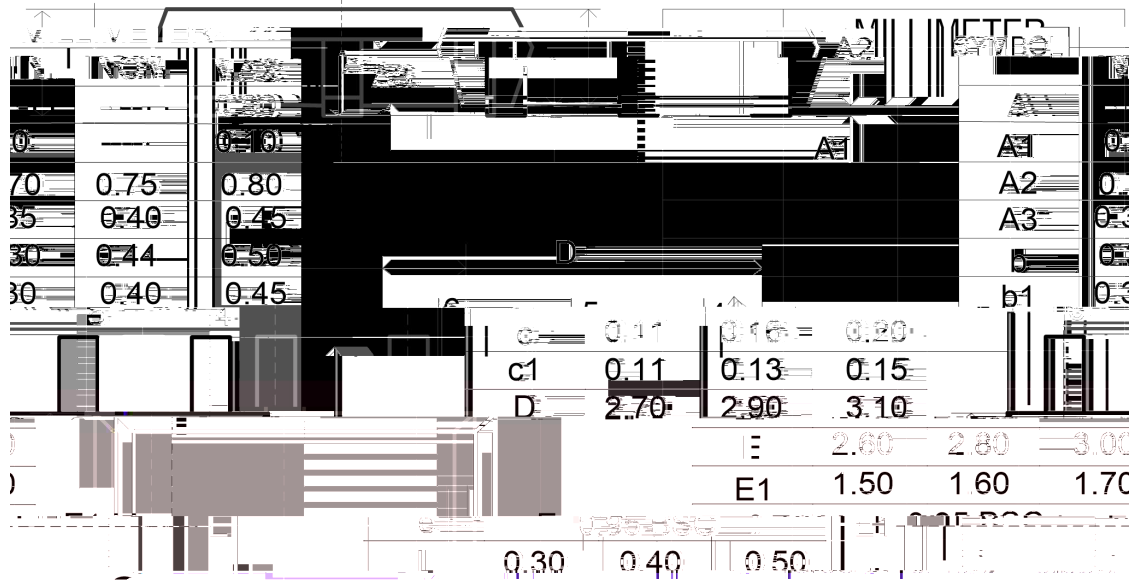



# **MICHIP**

---
